



CUSTOM MADE CABINS

LOG CABINS

WOODEN SUMMERHOUSES

TIMBER GARAGES



TIMBER
Cabins UK.

07908 106316

info@timbercabins-uk.com

www.timbercabins.com

instagram.com/timbercabinsuk

facebook.com/timbercabinsuk

Brighton

Size 3x3 m
Size 4x3 m

£5286 4x3



44 mm straight



44 mm angle*



- Log thickness 44 mm
- Double glazed doors and windows
- Double rubber gasket for windows and doors
- Ridge height up to 2.5 m
- Roof and floor boards from 19 mm thickness, T&G
- Canopy – 0.5 m
- Assembly kit (including nails for bitumen shingles)
- Bitumen shingles are supplied as optional extras
- This model is reversible (during installation)
- Can be made up to 2.5 m height to meet planning permission, on request

* Rounded notches maybe available on request.

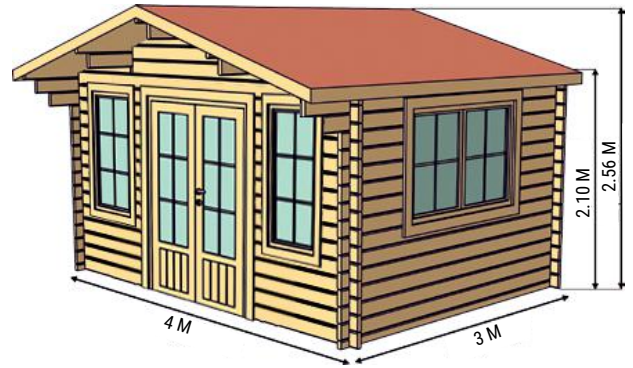

mm	m	m	m ²	m	m	m	m ²	vnt.	vnt.	mm	+
44	3x3	2.8x2.8	7.35	2.10	2.56	0.5	11.9	1	3	19	+
44	4x3	3.8x2.8	10.07	2.10	2.56	0.5	15.37	1	3	19	+

Kent

Size 3x2.5 m

£3299



44 mm straight



44 mm angle*



- Log thickness 44 mm
- Double glazed doors and windows
- Double rubber gasket for windows and doors
- Ridge height up to 2.5 m
- Assembly kit (including nails for bitumen shingles)
- Bitumen shingles are supplied as optional extras
- Roof and floor boards from 19 mm thickness, T&G
- This model is reversible (during installation)

* Rounded notches maybe available on request.

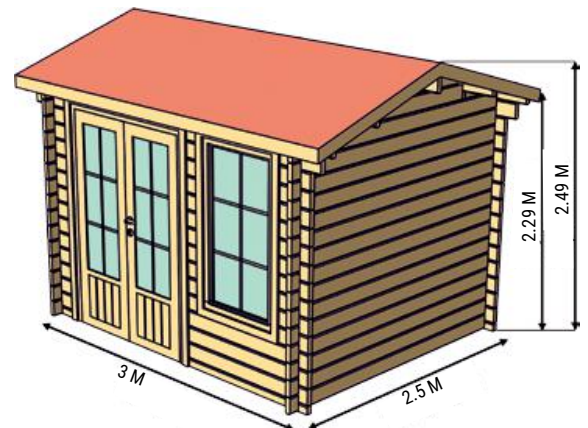

mm	m	m	m ²	m	m	m	m ²	vnt.	vnt.	mm	+
44	3x2.5	2.8x2.3	6	2.29	2.49	0.3	10	1	1	19	+

Nataly

Size 5x3 m

£5408



44 mm straight



44 mm angle*



- Log thickness 44 mm
- Double glazed doors and windows
- Double rubber gasket for windows and doors
- Ridge height up to 2.5 m
- Roof and floor boards from 19 mm thickness, T&G
- Floor boards for storage room only
- Front wall height – 2.43 m
- Side window 0.75x1.55 m
- Room size 2.73x2.73 m
- Assembly kit (including nails for bitumen shingles)
- Bitumen shingles are supplied as optional extras
- This model is reversible (during installation)

* Rounded notches maybe available on request.

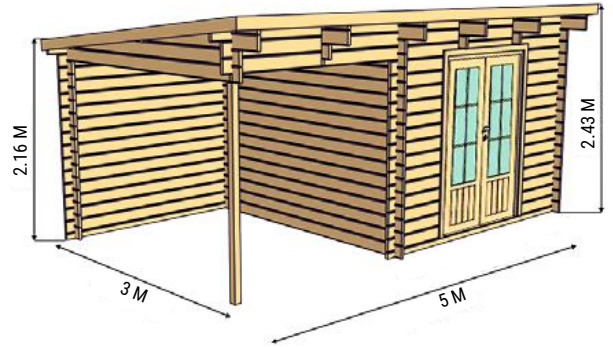

mm

44



m

5x3



m

4.82x2.82



m²

7.49



m

2.16



m

2.43



m

0.34



m²

16.88



vnt.

1



vnt.

1



mm

19



+

Bravo

Size 8x4 m

£8599



44 mm straight



44 mm angle*



- Log thickness 44 mm
- Double glazed doors and windows
- Double rubber gasket for windows and doors
- Ridge height up to 2.5 m
- Room size 4.73x3.73 m
- Assembly kit (including nails for bitumen shingles)
- Bitumen shingles are supplied as optional extras
- Roof and floor boards from 19 mm thickness, T&G
- Floor boards for the room only
- This model is reversible (during installation)

* Rounded notches maybe available on request.

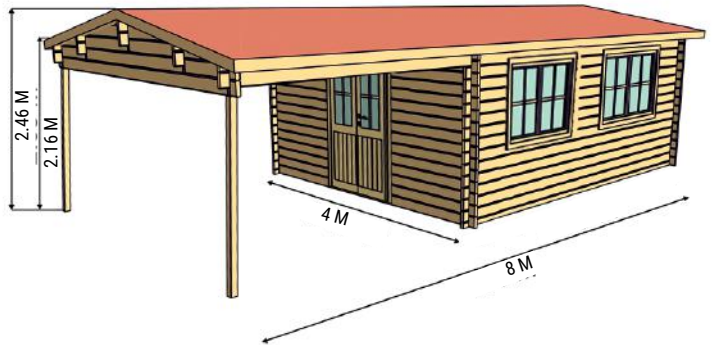

mm

44



m

8x4



m

4.82x3.82



m²

17.62



m

2.16



m

2.46



m

34.8



m²

8



vnt.

1



vnt.

2



mm

19



+

Pod

From £4245

- Size 3x3 m
- Size 4x3 m
- Size 4x4 m
- Size 4x5 m



- Log thickness 42 mm
- Double glazed doors and windows
- Double rubber gasket for windows and doors
- Ridge height can be up to 2.5 m
- Canopy – 0.5 m
- Assembly kit (including nails for bitumen shingles)
- Bitumen shingles are supplied as optional extras
- Roof and floor boards from 19 mm thickness, T&G

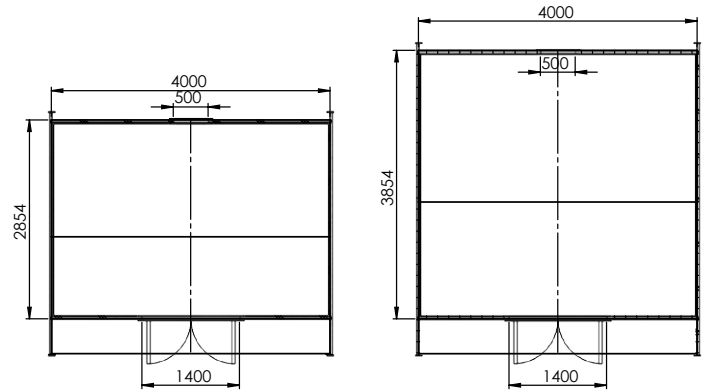

mm	m	m	m ²	m	m	m	m ²	vnt.	vnt.	mm	
44	3x3	3.5x3	8.71	-	2.80	0.4	21	1	1	19	-
44	4x3	4x3.354	10.34	-	2.50	0.4	24.5	1	1	19	-

Pod with bedroom

- Size 4x5 m
- Size 4x6 m
- Size 4x7 m

TBA



- Log thickness 42 mm
- Double glazes door and windows
- Double rubber gasket for windows and doors
- Ridge height can be up to 2.5 m
- Canopy – 0.5 m
- Assembly kit (including nails for bitumen shingles)
- Bitumen shingles are supplied as optional extras
- Floor boards from 19 mm thickness, T&G

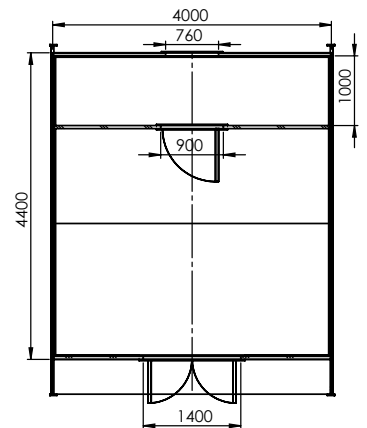

mm	m	m	m ²	m	m	m	m ²	vnt.	vnt.	mm	
44	4x4.4	9x4.9	16.8	-	2.5	0.5	38.5	1	1	19	-

Nida

Size 5x3 m

£5550



44 mm straight



44 mm angle*



- Log thickness 44 mm
- Double glazed doors and windows
- Double rubber gasket for windows and doors
- Ridge height up to 2.5 m
- Canopy – 0.5 m
- Assembly kit (including nails for bitumen shingles)
- Bitumen shingles are supplied as optional extras
- Roof and floor boards from 19 mm thickness, T&G
- This model is reversible (during installation)

* Rounded notches maybe available on request.

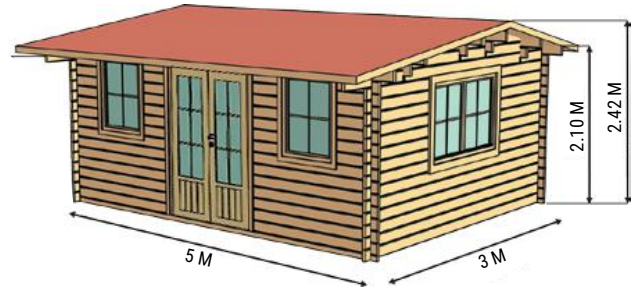

44 mm	5x3 m	4.8x2.8 m ²	12.78 m ³	2.10 m	2.42 m	0.5 m	19.8 m ²	1 vnt.	3 vnt.	19 mm	+	

Rome

Size 5x3 m

£5999



44 mm straight



44 mm angle*



- Log thickness 44 mm
- Double glazed doors and windows
- Double rubber gasket in windows and doors
- Ridge height up to 2.5 m
- Canopy – 0.3 m
- Assembly kit (including nails for bitumen shingles)
- Bitumen shingles are supplied as optional extras
- Roof and floor boards from 19 mm thickness, T&G
- This model is reversible (during installation)

* Rounded notches maybe available on request.

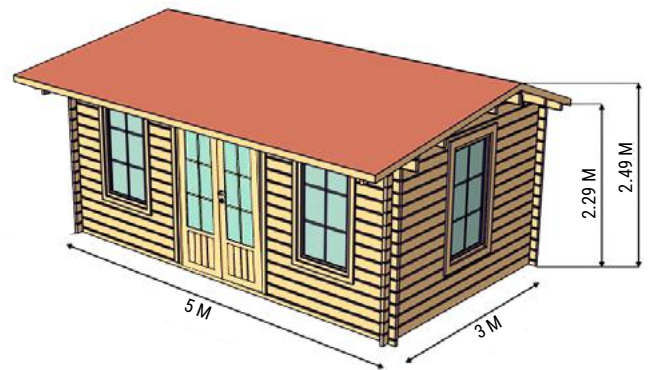

44 mm	5x3 m	4.8x2.8 m ²	12.78 m ³	2.29 m	2.49 m	0.3 m	19.8 m ²	1 vnt.	3 vnt.	19 mm	+	

Torino / Atlant

Size 5x4 m

£6999



44 mm straight



44 mm angle*



- Log thickness 44 mm
- Double glazed doors and windows
- Double rubber gasket for windows and doors (in 44 mm model)
- Front wall height up to 2.5 m
- Canopy – 0.345 m
- Assembly kit (including nails for bitumen shingles)
- Bitumen shingles are supplied as optional extras
- Roof and floor boards from 19 mm thickness, T&G

* Rounded notches maybe available on request.

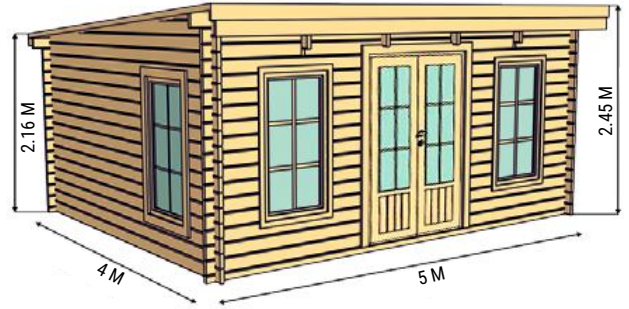

mm

44



m

5x4



m

4.8x3.8



m²

17.49



m

2.16



m

2.45



m

0.35



m²

22.5



vnt.

1



vnt.

4



mm

19



-

Oxford

Size 4x3 m

Size 5x4 m

£5999

£7250



44 mm straight



44 mm angle*



- Log thickness 44 mm
- Double glazed doors and windows
- Double rubber gasket for windows and doors
- Assembly kit (including nails for bitumen shingles)
- Bitumen shingles are supplied as optional extras
- Roof and floor boards from 19 mm thickness, T&G
- Can be made up to 2.5 m height to meet planning permission, on request

* Rounded notches maybe available on request.

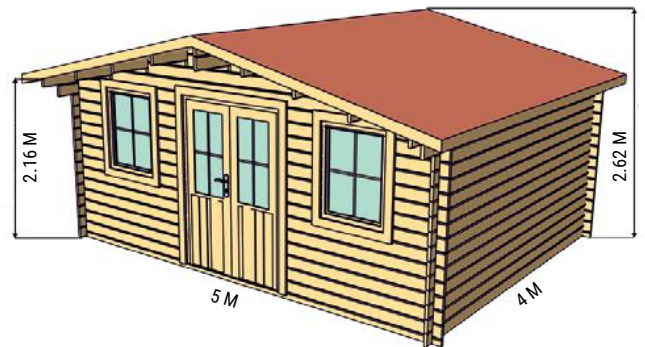

mm

44



m

4x3



m

3.80x2.80



m²

10.19



m

2.09



m

2.43



m

0.5



m²

14.88



vnt.

1



vnt.

2



mm

19



-

Derby

Size 4.5x3 m

£5999



44 mm straight



44 mm angle*



- Log thickness 44 mm
- Double glazed doors and windows
- Double rubber gasket for windows and doors
- Ridge height up to 2.5 m
- Roof and floor boards from 19 mm thickness, T&G
- Two premises with separate entries
- Double door + side shed door
- Assembly kit (including nails for bitumen shingles)
- Bitumen shingles are supplied as optional extras
- This model is reversible (during installation)

* Rounded notches maybe available on request.

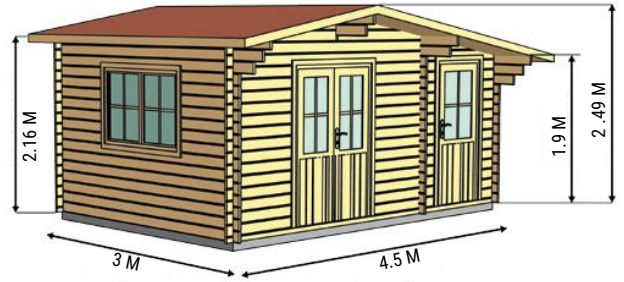

mm

44



m

4.5x3



m

4.3x2.8



m²

11.3



m

2.16;
1.9



m

2.49



m

0.5



m²

18.2



vnt.

2



vnt.

1



mm

19



+

Rumus

Size 4x3 m

Size 5x4 m

£6299

£7799



44 mm straight



44 mm angle*



- Log thickness 44 mm
- Double glazed doors and windows
- Double rubber gasket for windows and doors (in 44 mm model)
- Ridge height up to 2.5 m
- Assembly kit (including nails for bitumen shingles)
- Bitumen shingles are supplied as optional extras
- Roof and floor boards from 19 mm thickness, T&G
- This model is reversible (during installation)

* Rounded notches maybe available on request.

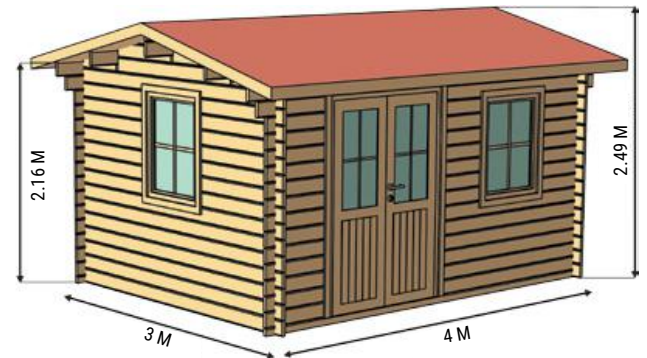

mm

44



m

4x3



m

3.8x2.8



m²

10.07



m

2.16



m

2.49



m

0.3



m²

15.2



vnt.

1



vnt.

3



mm

19



+

Verona

Size 5x4 m

£7999



44 mm straight



44 mm angle*



- Log thickness 44 mm
- Double glazed doors and windows
- Double rubber gasket for windows and doors
- Assembly kit (including nails for bitumen shingles)
- Bitumen shingles are supplied as optional extras
- Roof and floor boards from 19 mm thickness, T&G
- This model is reversible (during installation)
- Can be made up to 2.5 m height to meet planning permission, on request

* Rounded notches maybe available on request.

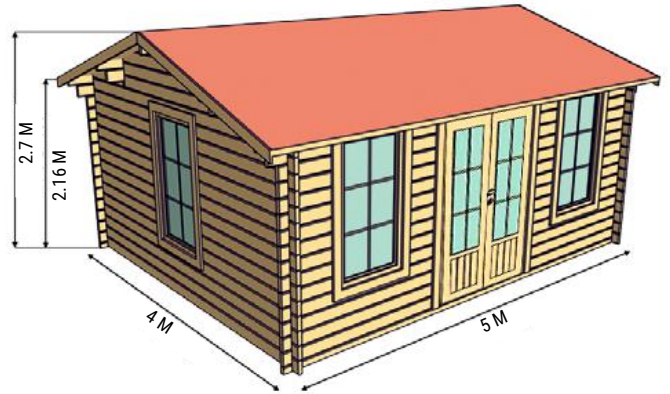

44	5x4	4.8x3.8	17.49	2.16	2.70	0.3	24	1	3	19	+

Alpina

Size 4x3 m

Size 5x4 m

£5999

£6999



44 mm straight



44 mm angle*



- Log thickness 44 mm
- Double glazed doors and windows
- Double rubber gasket for windows and doors
- Assembly kit (including nails for bitumen shingles)
- Bitumen shingles are supplied as optional extras
- Roof and floor boards from 19 mm thickness, T&G
- Terrace boards
- This model is reversible (during installation)

* Rounded notches maybe available on request.

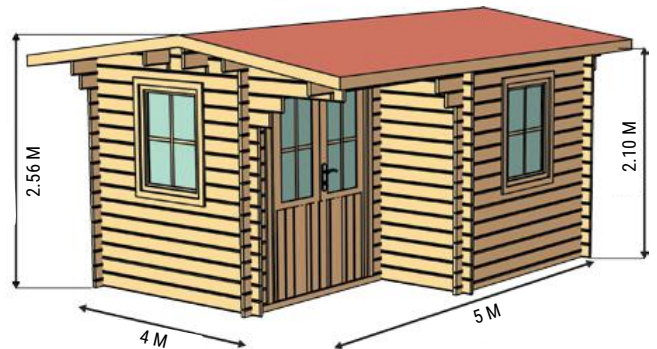

44	4x3	3.8x2.8	8.19	2.10	2.56	0.25	14.2	1	2	19	+

Monaco

- Size 3x2 m
- Size 3x3 m
- Size 3x4 m
- Size 4x3 m
- Size 4x4 m
- Size 4x5 m
- Size 5x4 m
- Size 5x5 m

From £5290



44 mm straight



44 mm angle*



- Log thickness 44 mm
- Double glazed doors and windows
- Double rubber gasket for windows and doors
- Assembly kit (including nails for bitumen shingles)
- Bitumen shingles are supplied as optional extras
- Roof and floor boards from 19 mm thickness, T&G
- This model is reversible (during installation)
- Can be made up to 2.5 m height to meet planning permission, on request

Note: 3x2 m, 3x3 m, 3x4 m has single window in front
* Rounded notches maybe available on request.

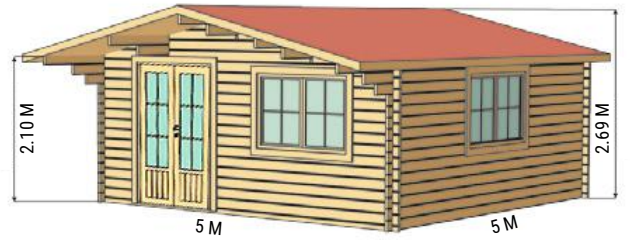

mm	m	m	m ²	m	m	m	m ²	vnt.	vnt.	mm	
44	3x3	2.8x2.8	7.35	2.03	2.36	1	14.28	1	2	19	+
44	3x4	2.8x3.8	10.1	2.03	2.36	1	17.4	1	2	19	+
44	4x3	3.8x2.8	10.1	2.10	2.42	1	18.19	1	2	19	+
44	4x4	3.8x3.8	13.78	2.03	2.39	1	21.96	1	2	19	+
44	4x5	3.8x4.8	17.49	2.03	2.62	1	27.34	1	2	19	+
44	5x4	4.8x3.8	17.49	2.10	2.69	1	27.61	1	2	19	+
44	5x5	4.8x4.8	22.2	2.10	2.69	1	32.4	1	2	19	+

Faro

- Size 3x3 m
- Size 3x4 m
- Size 4x3 m
- Size 4x4 m
- Size 4x5 m
- Size 5x4 m
- Size 5x5 m

From £5400



44 mm straight



44 mm angle*



- Log thickness 44 mm
- Double glazed doors and windows
- Double rubber gasket for windows and doors
- Assembly kit (including nails for bitumen shingles)
- Bitumen shingles are supplied as optional extras
- Roof and floor boards from 19 mm thickness, T&G
- This model is reversible (during installation)
- Can be made up to 2.5 m height to meet planning permission, on request

Note: 3x3 m, 3x4 m has single window in front
* Rounded notches maybe available on request.



mm	m	m	m ²	m	m	m	m ²	vnt.	vnt.	mm	
44	3x3	2.8x2.8	7.35	2.10	2.56	1	13.6	1	2	19	+
44	3x4	2.8x3.8	10.1	2.10	2.42	1	17.9	1	2	19	+
44	4x3	3.8x2.8	10.1	2.10	2.56	1	18.22	1	2	19	+
44	4x4	3.8x3.8	13.78	2.10	2.56	1	22.21	1	2	19	+
44	4x5	3.8x4.8	17.49	2.10	2.56	1	26.76	1	2	19	+
44	5x4	4.8x3.8	17.49	2.10	2.56	1	27.29	1	2	19	+
44	5x5	4.8x4.8	22.2	2.10	2.69	1	32.69	1	2	19	+

Milano

- Size 3x3 m
- Size 3x4 m
- Size 4x3 m
- Size 4x4 m
- Size 4x5 m
- Size 5x4 m
- Size 5x5 m

From £5999



44 mm straight



44 mm angle*



- Log thickness 44 mm
- Double glazed doors and windows
- Double rubber gasket for windows and doors
- Assembly kit (including nails for bitumen shingles)
- Bitumen shingles are supplied as optional extras
- Roof and floor boards from 19 mm thickness, T&G
- This model is reversible (during installation)
- Can be made up to 2.5 m height to meet planning permission, on request

Note: 3x3 m, 3x4 m has single window in front
* Rounded notches maybe available on request.

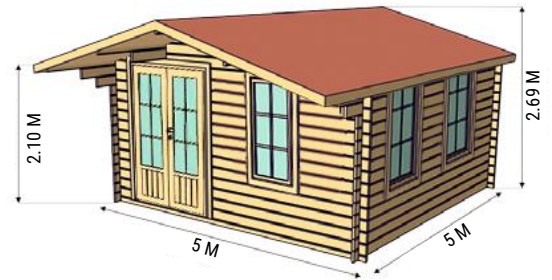

mm	m	m	m ²	m	m	m	m ²	vnt.	vnt.	mm	
44	3x3	2.8x2.8	7.35	2.10	2.69	1	14.28	1	2	19	+
44	3x4	2.8x3.8	10.1	2.10	2.69	1	17.4	1	2	19	+
44	4x3	3.8x2.8	10.1	2.10	2.69	1	18.19	1	2	19	+
44	4x4	3.8x3.8	13.78	2.10	2.69	1	21.96	1	3	19	+
44	4x5	3.8x4.8	17.49	2.10	2.69	1	27.34	1	3	19	+
44	5x4	4.8x3.8	17.49	2.10	2.69	1	27.61	1	3	19	+
44	5x5	4.8x4.8	22.2	2.10	2.69	1	34.4	1	3	19	+

York

Size 5x3 m

£5999

N/A



44 mm straight



44 mm angle*



- Log thickness 44 mm
- Double glazed doors and windows
- Double rubber gasket for windows and doors
- Ridge height up to 2.5 m
- Assembly kit (including nails for bitumen shingles)
- Bitumen shingles are supplied as optional extras
- Roof and floor boards from 19 mm thickness, T&G
- This model is reversible (during installation)

* Rounded notches maybe available on request.

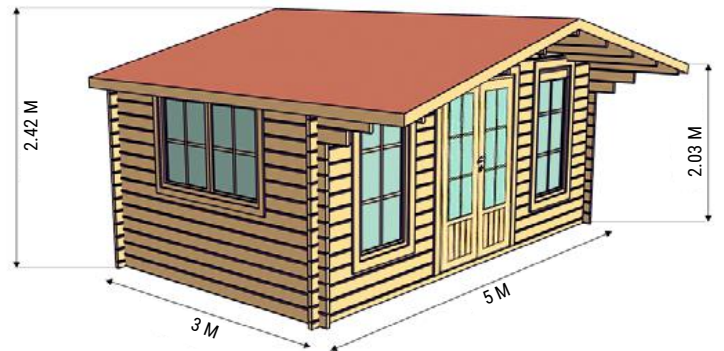

mm	m	m	m ²	m	m	m	m ²	vnt.	vnt.	mm	
44	5x3	4.8x2.8	12.78	2.03	2.42	0.9	22.48	1	3	19	+

Bremen

- Size 4x4 m
- Size 4x5 m
- Size 5x4 m
- Size 5x5 m

N/A



70 mm straight



70 mm angle*



- Log thickness 70 mm
- Double glazed doors and windows
- Double rubber gasket for windows and doors
- Assembly kit (including nails for bitumen shingles)
- Bitumen shingles are supplied as optional extras
- Roof and floor boards from 19 mm thickness, T&G
- This model is reversible (during installation)
- Can be made up to 2.5 m height to meet planning permission, on request

* Rounded notches maybe available on request.

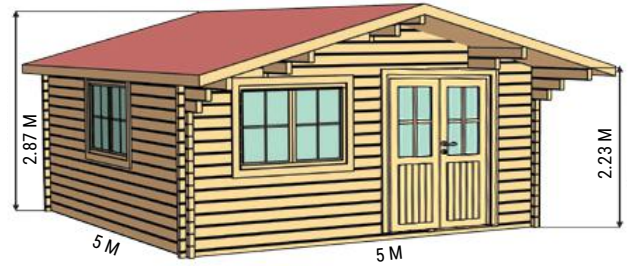

mm	m	m	m ²	m	m	m	m ²	vnt.	vnt.	mm	
70	4x4	3.78x3.78	13.28	2.09	2.57	1	25.76	1	2	19	+
70	4x5	3.78x4.78	16.92	2.09	2.57	1	27.6	1	2	19	+
70	5x4	4.78x3.78	16.92	2.09	2.57	1	27.6	1	2	19	+
70	5x5	4.78x4.78	21.57	2.09	2.57	1	34.2	1	2	19	+

Head office

- Size 5x4 m
- Size 6x5 m

£8250

£9999



44 mm straight



44 mm angle*



70 mm straight



70 mm angle*



- Standard log thickness 44 mm. Log thickness 70 mm maybe available on request.
- Double glazed doors and windows
- Double rubber gasket for windows and doors
- Assembly kit (including nails for bitumen shingles)
- Bitumen shingles are supplied as optional extras
- Roof and floor boards from 19 mm thickness, T&G
- Partition for WC room 1x2.5m, internal door included
- This model is reversible (during installation)

* Rounded notches maybe available on request.

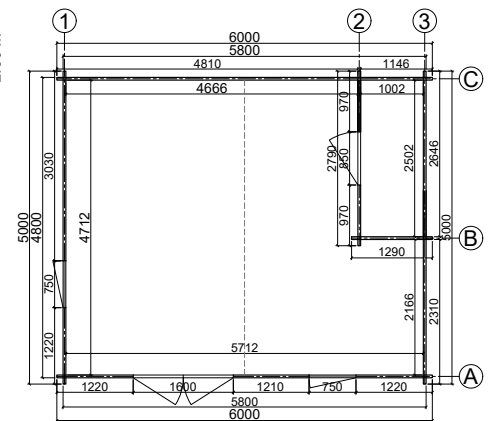
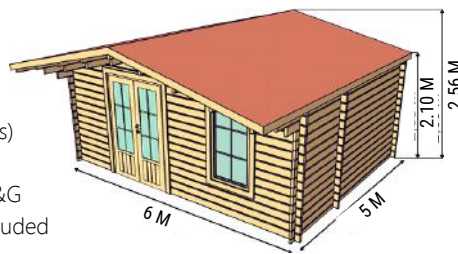

mm	m	m	m ²	m	m	m	m ²	vnt.	vnt.	mm	
44	5x4	4.8x3.8	17.49	2.10	2.56	1	27.61	2	2	19	-
44	6x5	4.8x5.8	26.91	2.10	2.56	1	36.72	2	2	19	-

Clockhouse

Size 4x3 m

Size 5x4 m

£5372

£6188



44 mm straight



44 mm angle*



- Log thickness 44 mm
- Double glazed doors and windows
- Double rubber gasket for windows and doors
- 4x3 m - ridge height up to 2.5 m
- Assembly kit (including nails for bitumen shingles)
- Bitumen shingles are supplied as optional extras
- Roof and floor boards from 19 mm thickness, T&G
- This model is reversible (during installation)

* Rounded notches maybe available on request.

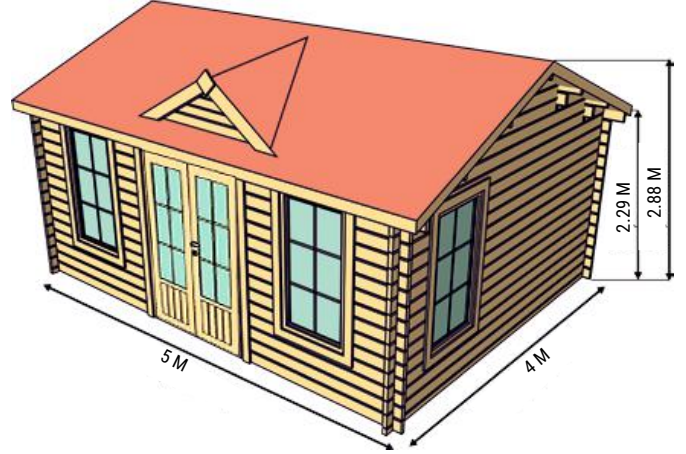

44	4x3	3.8x2.8	10.1	2.16	2.49	0.25	14.45	1	3	19	+

Parma

Size 6x4 m

Discontinued



44 mm straight



44 mm angle*



60 mm straight



60 mm angle*



- Log thickness 44 mm. Log thickness 60 mm maybe available on request.
- Double glazes door and windows
- Double rubber gasket for windows and doors
- Ridge height - 3.12 m
- Assembly kit (including nails for bitumen shingles)
- Bitumen shingles are supplied as optional extras
- Roof and floor boards from 19 mm thickness, T&G

* Rounded notches maybe available on request.

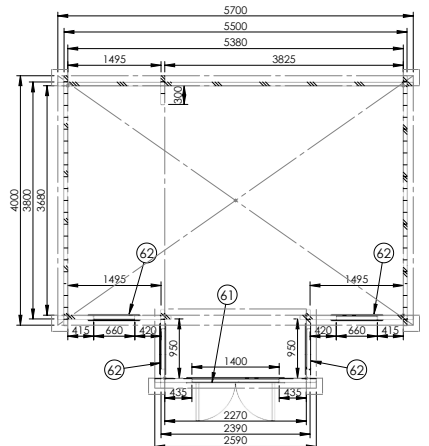

44	5.7x9	5.5x3.8 2.39x1.01	21.73	2.34	2.795	0.2	33	1	4	19	-

Dover

Size 6x4 m

£8999



44 mm straight



44 mm angle*



- Standard log thickness 44 mm
- Double glazed doors and windows
- Double rubber gasket for windows and doors
- Side room 1.96 m wide
- Front wall height up to 2.5 m
- Assembly kit (including nails for bitumen shingles)
- Bitumen shingles are supplied as optional extras
- Roof and floor boards from 19 mm thickness, T&G

* Rounded notches maybe available on request.

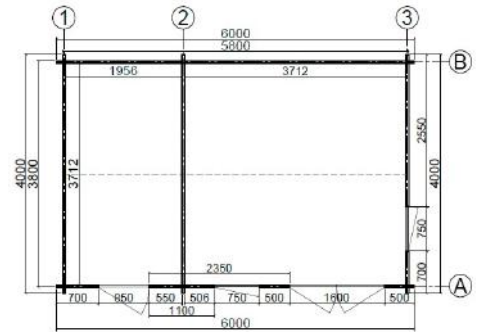
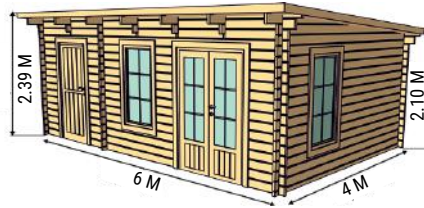

mm

44



m

6x4



m

5.81x3.81



m²

7.261
13.78



m

2.10



m

2.39



m

0.38



m²

27



vnt.

2



vnt.

2



mm

19



-

Rose

Size 6x4 m

£10799



44 mm straight



44 mm angle*



70 mm straight



70 mm angle*



- Standard log thickness 44 mm. Log thickness 70 mm maybe available on request.
- Double glazed doors and windows
- Double rubber gasket for windows and doors
- Side room 1.96 m wide
- Ridge height up to 2.5 m
- Assembly kit (including nails for bitumen shingles)
- Bitumen shingles are supplied as optional extras
- Roof and floor boards from 19 mm thickness, T&G

* Rounded notches maybe available on request.

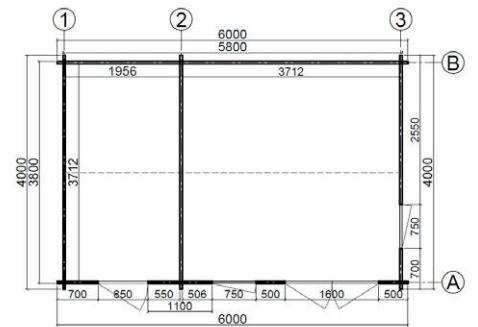

mm

44



m

6x4



m

5.8x3.8



m²

7.261
13.78



m

2.10



m

2.42



m

0.25



m²

27.96



vnt.

2



vnt.

2



mm

19



-

Amber

Size 6x4 m

£10350



44 mm straight



44 mm angle*



- Log thickness 44 mm
- Double glazes door and windows
- Double rubber gasket for windows and doors
- Ridge height - 2.6 m
- Assembly kit (including nails for bitumen shingles)
- Bitumen shingles are supplied as optional extras
- Roof and floor boards from 19 mm thickness, T&G
- Can be made up to 2.5 m height to meet planning permission, on request

Living area – 20.94 m²

* Rounded notches maybe available on request.

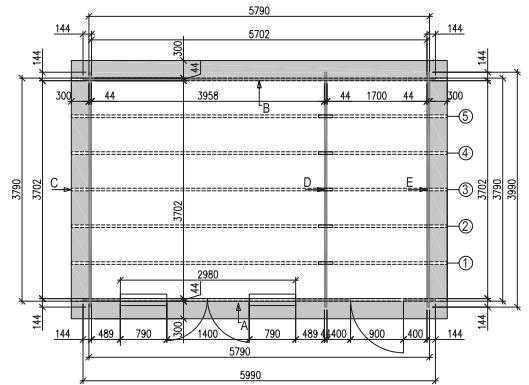

44	6x4	5.813x3.813	20.94	2.21	2.6	0.3	28.6	2	2	19	-

Malta

Size 5x5.12 m

£9250



44 mm straight



44 mm angle*

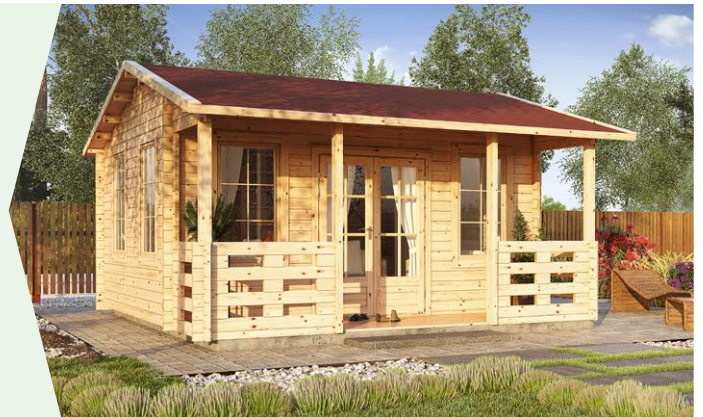

- Log thickness 44 mm
- Double glazed doors and windows
- Double rubber gasket for windows and doors
- Assembly kit (including nails for bitumen shingles)
- Bitumen shingles are supplied as optional extras
- Roof and floor boards from 19 mm thickness, T&G
- Veranda with canopy 0.94 m (terrace boards included)
- This model is reversible (during installation)

* Rounded notches maybe available on request.

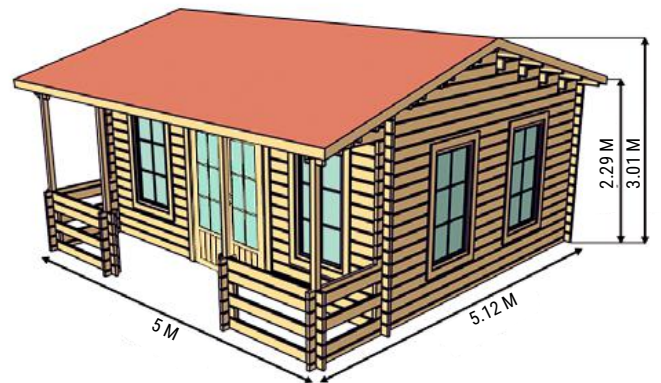

44	5x5.12	4.8x4.92	17.49	2.29	3.01	1.12	30.58	1	4	19	+

Gorbea

Size 5x5.9 m

£10650



44 mm straight



44 mm angle*



70 mm straight



70 mm angle*



- Standard log thickness 44 mm. Log thickness 70 mm maybe available on request.
- Double glazed doors and windows
- Double rubber gasket for windows and doors
- Assembly kit (including nails for bitumen shingles)
- Bitumen shingles are supplied as optional extras
- Roof and floor boards from 19 mm thickness, T&G
- Veranda with canopy 1.86 m (terrace boards included)
- This model is reversible (during installation)

Living area – 17.48 m²

* Rounded notches maybe available on request.

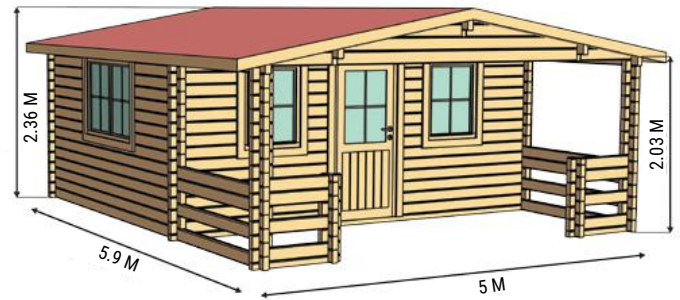

44	5x5.9	4.8x5.7	17.52	2.03	2.36	1.8	34	1	4	19	+

Roy hot tub cabin

Size 4x6 m

£8999



44 mm straight



44 mm angle*



- Log thickness 44 mm
- Double glazed doors and windows
- Double rubber gasket for windows and doors
- Veranda with large canopy 2.4 m (terrace boards included)
- Assembly kit (including nails for bitumen shingles)
- Bitumen shingles are supplied as optional extras
- Roof and floor boards from 19 mm thickness, T&G
- This model is reversible (during installation)
- Can be made up to 2.5 m height to meet planning permission, on request

* Rounded notches maybe available on request.

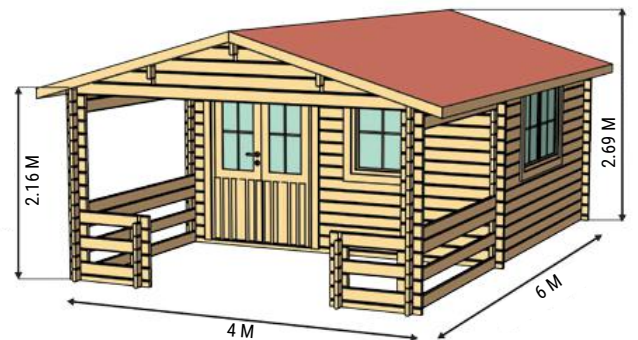

44	4x6	3.8x5.8	21.2	2.16	2.69	2.4	27.8	1	2	19	+

Palermo

Size 5x5.9 m

£10999



44 mm straight



44 mm angle*



70 mm straight



70 mm angle*



- Standard log thickness 44 mm. Log thickness 70 mm maybe available on request.
- Double glazed doors and windows
- Double rubber gasket for windows and doors
- Assembly kit (including nails for bitumen shingles)
- Bitumen shingles are supplied as optional extras
- Roof and floor boards from 19 mm thickness, T&G
- This model is reversible (during installation)

Living area – 27.10 m²

* Rounded notches maybe available on request.

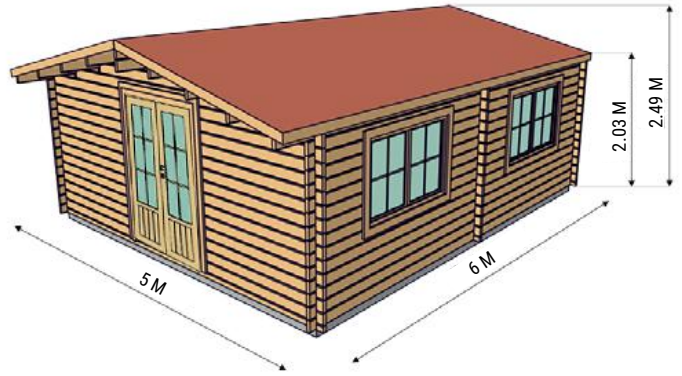

44	5x6	4.8x5.8	26.71	2.03	2.49	0.4	34.79	2	3	19	+

Manchester

Size 4x5.85 m

LOG THICKNESS NOW 70mm

£11250



44 mm straight



44 mm angle*



- Log thickness 44 mm
- Double glazed doors and windows
- Double rubber gasket for windows and doors
- Veranda with canopy 1.86 m (terrace boards included)
- Assembly kit (including nails for bitumen shingles)
- Bitumen shingles are supplied as optional extras
- Roof and floor boards from 19 mm thickness, T&G
- This model is reversible (during installation)
- Can be made up to 2.5 m height to meet planning permission, on request

* Rounded notches maybe available on request.

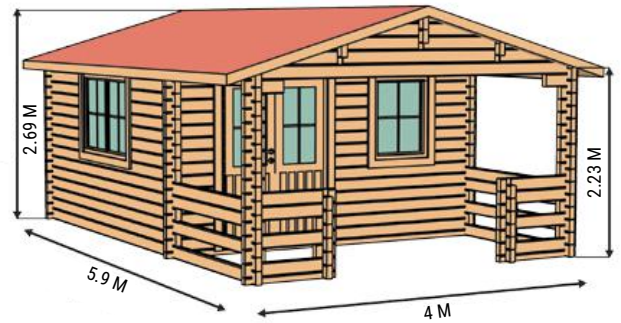

44	4x5.9	3.8x5.7	13.28	2.09	2.62	1.87	30	1	2	19	+

Paris

Size 6x6 m

£18999

44mm



44 mm straight



44 mm angle*



70 mm straight



70 mm angle*



90 mm straight



- Standard log thickness 44 mm. Log thickness 70/90 mm maybe available on request.
- Double glazed doors and windows
- Double rubber gasket for windows and doors
- Assembly kit (including nails for bitumen shingles)
- Bitumen shingles are supplied as optional extras
- Roof and floor boards from 19 mm thickness, T&G
- Canopy – 1.5 m (terrace boards included)

Living area – 32.5 m²

* Rounded notches maybe available on request.

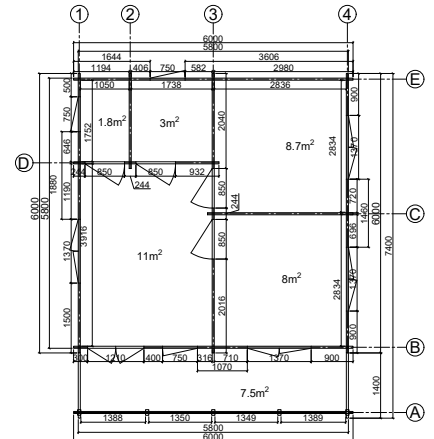

44



6x6



5.83x7.2



32.31



2.09



2.90



1.5



45.92



5



7



19



-

Oslo

Size 6x4 m

£7999



44 mm straight



44 mm angle*



70 mm straight



70 mm angle*



- Standard log thickness 44 mm. Log thickness 70 mm maybe available on request.
- Double glazed doors and windows
- Double rubber gasket for windows and doors
- Ridge height up to 2.5 m
- Assembly kit (including nails for bitumen shingles)
- Bitumen shingles are supplied as optional extras
- Roof and floor boards from 19 mm thickness, T&G
- This model is reversible (during installation)

* Rounded notches maybe available on request.

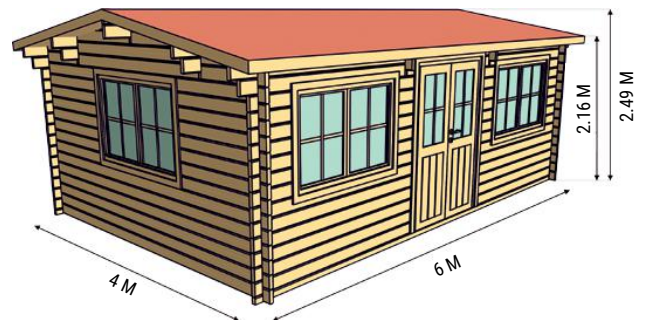

44



6x4



5.8x3.8



21.2



2.16



2.49



0.2



27.28



1



2



19



+

Fay / Royal

Size 6x6 m

£18999

44mm



44 mm straight



44 mm angle*



90 mm straight



70 mm straight



70 mm angle*



44-50-44 mm straight



- Standard log thickness of Fay: 44 mm, Royal: 44-50-44 mm. Log thickness 70/90 mm maybe available on request.
- Double glazed doors and windows
- Double rubber gasket for windows and doors
- Assembly kit (including nails for bitumen shingles)
- Bitumen shingles are supplied as optional extras
- Roof and floor boards from 19 mm thickness, T&G
- Canopy – 1 m (terrace boards included)

Living area – 29 m²

* Rounded notches maybe available on request.

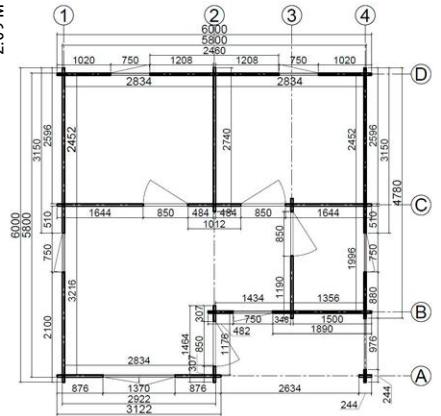
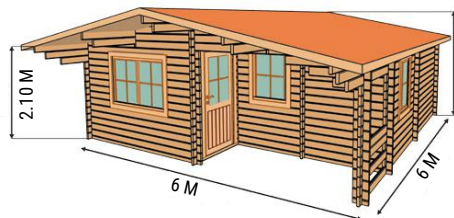

44	6x6	5.8x5.8	28.58	2.10	2.69	1.1	46.2	4	6	19	-

Bordo

Size 7x6 m

£26999

44mm



44 mm straight



44 mm angle*



70 mm straight



70 mm angle*



90 mm straight



- Standard log thickness 44 mm. Log thickness 70/90 mm maybe available on request.
- Double glazed doors and windows
- Double rubber gasket for windows and doors
- Assembly kit (including nails for bitumen shingles)
- Bitumen shingles are supplied as optional extras
- Roof and floor boards from 19 mm thickness, T&G
- Terrace boards included

Living area – 36.30 m²

* Rounded notches maybe available on request.

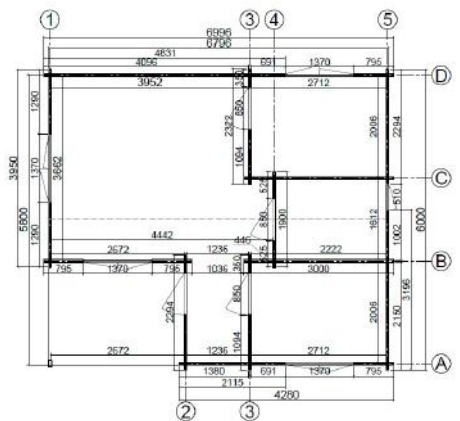
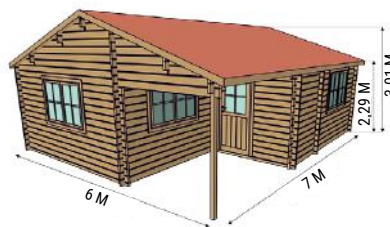

44	7x6	6.79x5.8	38	2.29	3.01	0.2	45.5	4	5	19	-

Linda

Size 8x4 m

£29999



44 mm straight



44 mm angle*



68 mm straight



68 mm angle*



- Standard log thickness 44 mm. Log thickness 60 mm maybe available on request.
- Double glazes door and windows
- Double rubber gasket for windows and doors
- Ridge height - 2.47 m
- Assembly kit (including nails for bitumen shingles)
- Bitumen shingles are supplied as optional extras
- Roof and floor boards from 19 mm thickness, T&G

Living area – 28.29 m²

* Rounded notches maybe available on request.

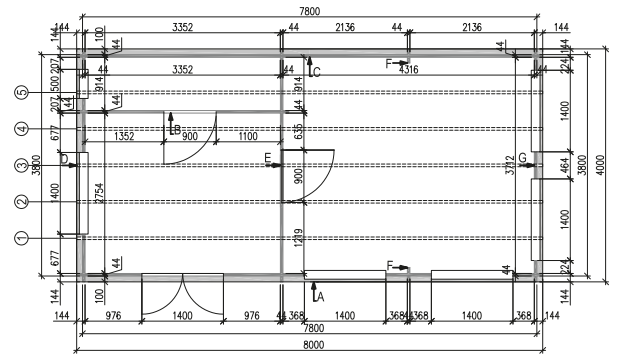

44	8x4	7.8x3.8	28.29	2.08	2.47	0.144	34	3	6	19	-

Bristol

Size 6x7 m

£27650



44 mm straight



44 mm angle*



70 mm straight



70 mm angle*



90 mm straight



- Standard log thickness 44 mm. Log thickness 70/90 mm maybe available on request.
- Double glazed doors and windows
- Double rubber gasket for windows and doors
- Assembly kit (including nails for bitumen shingles)
- Bitumen shingles are supplied as optional extras
- Roof and floor boards from 19 mm thickness, T&G
- This model is reversible (during installation)

Living area – 36.8 m²

* Rounded notches maybe available on request.

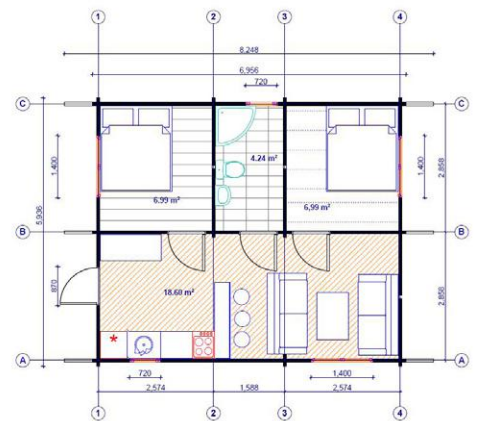
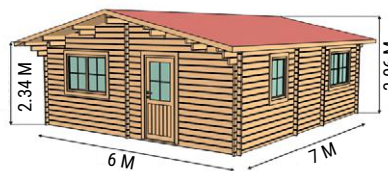

44	6x7	5.8x6.8	36.82	2.34	3.06	0.76	62	4	5	19	+

Nottingham

Size 4.5x6 m

£15999

44mm



44 mm straight



44 mm angle*



70 mm straight



70 mm angle*



- Standard log thickness 44 mm. Log thickness 70 mm maybe available on request.
- Double glazed doors and windows
- Double rubber gasket for windows and doors
- Assembly kit (including nails for bitumen shingles)
- Bitumen shingles are supplied as optional extras
- Roof and floor boards from 19 mm thickness, T&G
- This model is reversible (during installation)

Living area – 24 m² + 12 m² attic (ladders included)
 * Rounded notches maybe available on request.

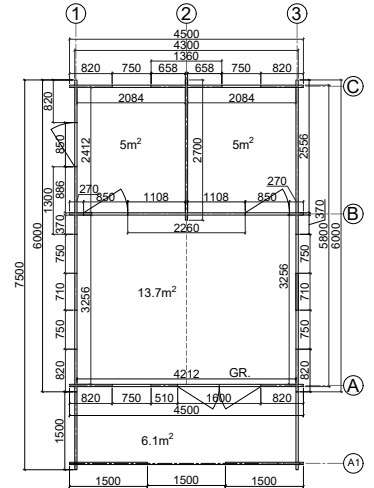
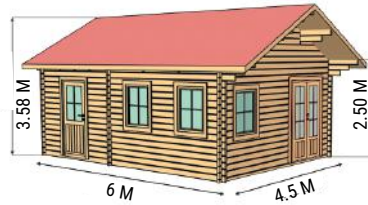

44	4.5x6	4.32x5.79	24.11 13.62	2.50	3.58	0.8	42.14	4	7	19	+

Baltic

Size 6x6 m

£27600



44 mm straight



44 mm angle*



70 mm straight



70 mm angle*



90 mm straight



- Standard log thickness 44 mm. Log thickness 70/90 mm maybe available on request.
- Double glazed doors and windows
- Double rubber gasket for windows and doors
- Assembly kit (including nails for bitumen shingles)
- Bitumen shingles are supplied as optional extras
- Roof and floor boards from 19 mm thickness, T&G
- Terrace boards included

Living area – 30.7 m²
 * Rounded notches maybe available on request.

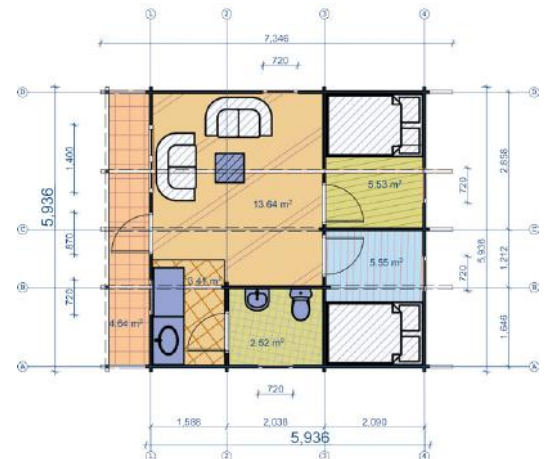
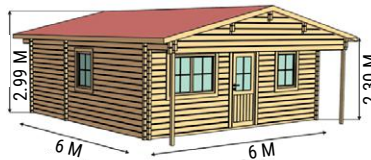

44	6x6	5.8x5.8	34.22	2.30	2.99	0.9	61	4	5	19	-

Spagna

Size 6x6.5 m

£29999



44 mm
straight



44 mm
angle*



70 mm
straight



70 mm
angle*



90 mm
straight



- Standard log thickness 44 mm. Log thickness 70/90 mm maybe available on request.
- Double glazed doors and windows
- Double rubber gasket for windows and doors
- Assembly kit (including nails for bitumen shingles)
- Bitumen shingles are supplied as optional extras
- Roof and floor boards from 19 mm thickness, T&G
- Canopy – 2.4 m (terrace boards included)

Living area – 35 m².

* Rounded notches maybe available on request.

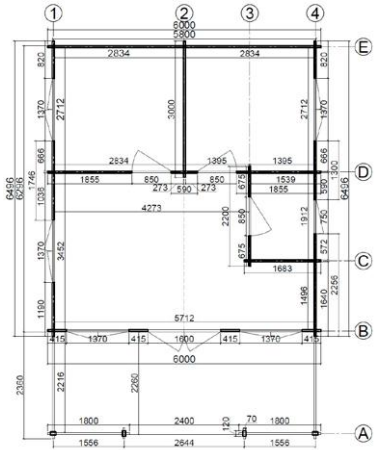

mm

44



m

6x6.5



m²

5.8x8.55



m²

35.1



m

2.03



m

2.49



m

2.26



m²

53.8



vnt.

4



vnt.

6



mm

19



mm

-



Aura

Aura Plus

(with annex)

Size 6x8 m

£32000



70 mm straight



44 mm straight



44 mm angle*



70 mm angle*



90 mm straight



- Standard log thickness 44 mm. Log thickness 70/90 mm maybe available on request.
- Double glazed doors and windows
- Double rubber gasket for windows and doors
- Assembly kit (including nails for bitumen shingles)
- Bitumen shingles are supplied as optional extras
- Roof and floor boards from 19 mm thickness, T&G
- Canopy – 2 m (terrace boards included)

Living area – 36 m² + 14 m² attic
(in Aura Plus model annex is 2.5 m²)

* Rounded notches maybe available on request.

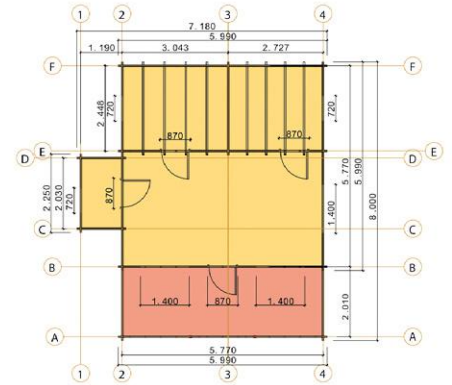
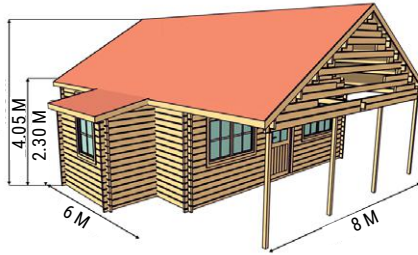

mm	m	m	m ²	m	m	m	m ²	vnt.	vnt.	mm	-
44	6x8	5.82x7.82	36 14	2.30	4.05	2	58.73	3	6	19	-
44	6x8	5.82x7.82	38.28 14	2.30	4.05	2	62	3	7	19	-



Typ

Size 5x10 m

£34650



44 mm
straight



44 mm
angle*



70 mm
straight



70 mm
angle*



90 mm
straight



- Standard log thickness 44 mm. Log thickness 70/90 mm maybe available on request.
- Double glazed doors and windows
- Double rubber gasket for windows and doors
- Assembly kit (including nails for bitumen shingles)
- Bitumen shingles are supplied as optional extras
- Roof and floor boards from 19 mm thickness, T&G
- Veranda with canopy 1.86 m (terrace boards included)

Living area – 37.50 m²

* Rounded notches maybe available on request.

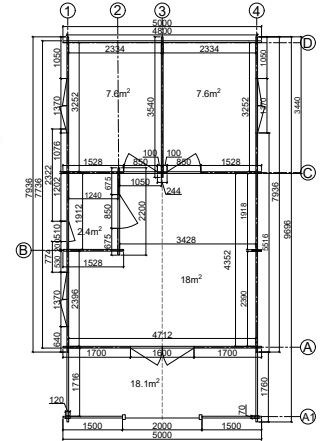
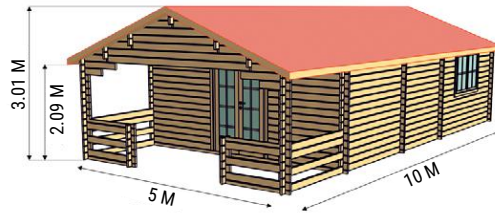

mm

44



m

5x10



m²

4.79x9.5



m²

34.95



m

2.09



m

3.01



m

1.78



m²

54.2



vnt.

4



vnt.

4



mm

19



-



Lora

Size 6x8.5 m

£35750



44 mm
straight



44 mm
angle*



70 mm
straight



70 mm
angle*



90 mm
straight



- Standard log thickness 44 mm. Log thickness 70/90 mm maybe available on request.
- Double glazed doors and windows
- Double rubber gasket for windows and doors
- Assembly kit (including nails for bitumen shingles)
- Bitumen shingles are supplied as optional extras
- Roof and floor boards from 19 mm thickness, T&G
- Terrace boards included

Living area – 39.28 m²

* Rounded notches maybe available on request.

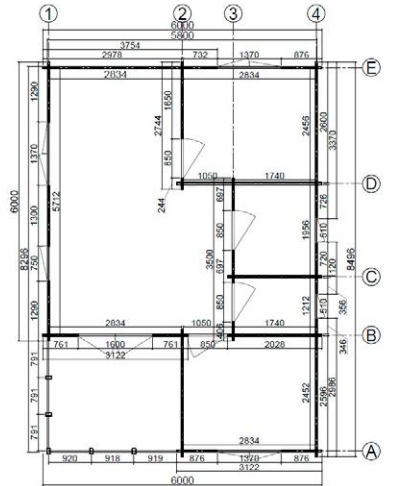

mm

44



m

6x8.5



m

5.78x8.3



m²

38.98



m

2.16



m

3.11



m

2.4



m²

51



vnt.

5



vnt.

6



mm

19



-



Lincoln

Size 6x9 m

£79000



70 mm straight



70 mm angle*



90 mm straight



- Standard log thickness 70 mm. Log thickness 90 mm maybe available on request.
- Double glazed doors and windows
- Double rubber gasket for windows and doors
- Assembly kit (including nails for bitumen shingles)
- Bitumen shingles are supplied as optional extras
- Roof and floor boards from 19 mm thickness, T&G
- Terrace boards and stairs included
- This model is reversible (during installation)

Living area of two storey log cabin – 85 m²

* Rounded notches maybe available on request.

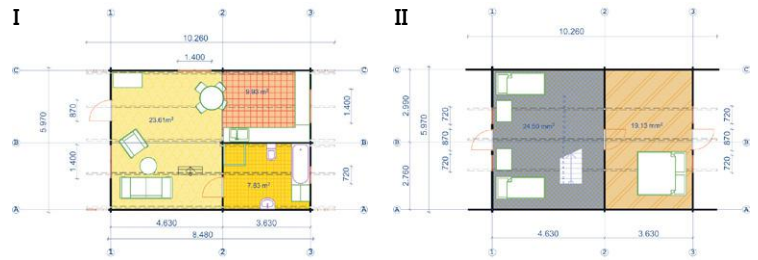
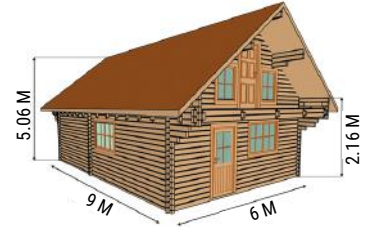

mm

70



m

6x9



m

5.8x8.3



m²

85



m

2.16



m

5.06



m

-



m²

111



vnt.

5



vnt.

8



mm

26



+

+

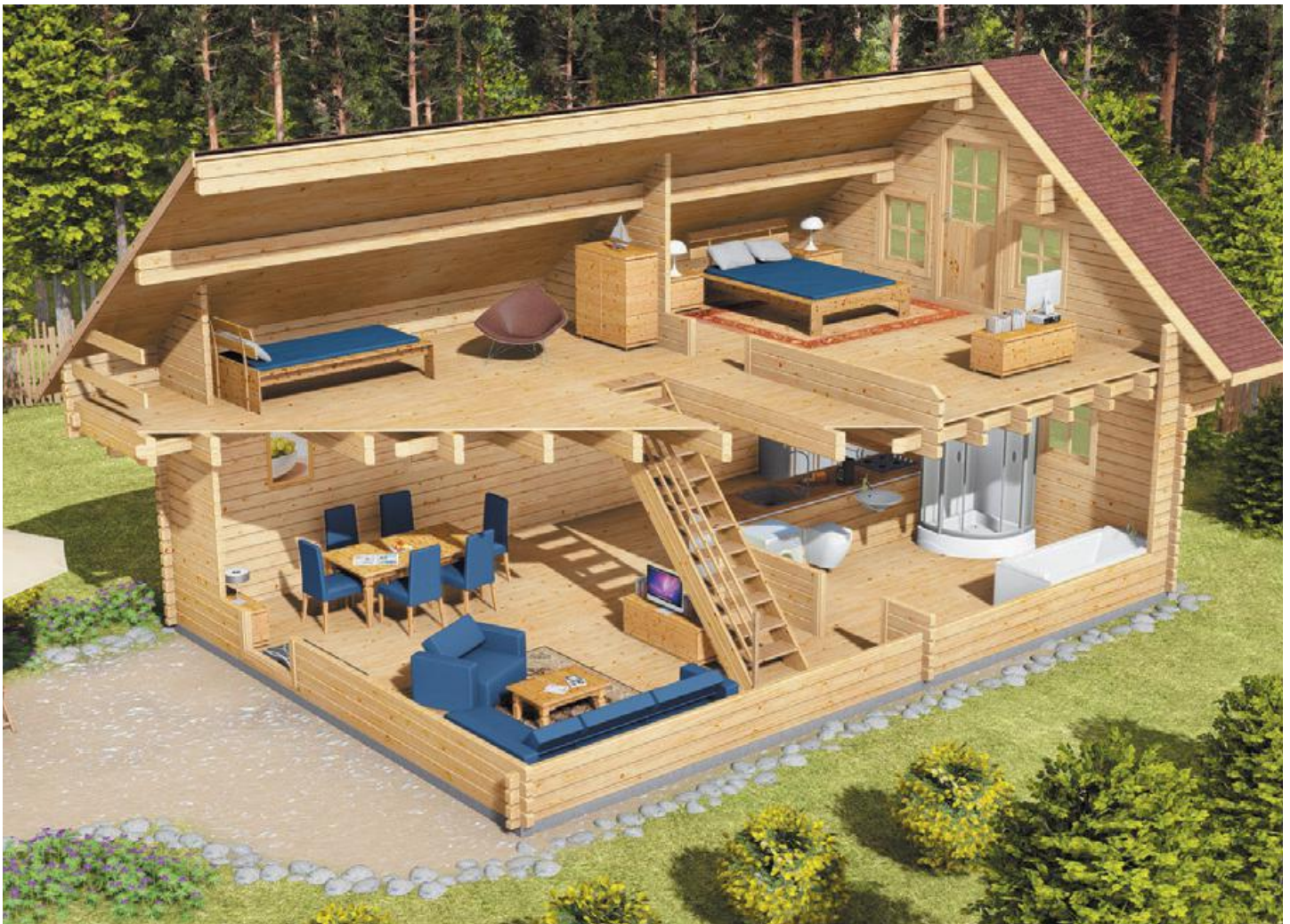

Katryn

Size 11x6 m

£397500

In 70mm



44 mm straight



44 mm angle*



70 mm straight



70 mm angle*



90 mm straight



- Standard log thickness 44 mm. Log thickness 70/90 mm maybe available on request.
- Double glazed doors and windows
- Double rubber gasket for windows and doors
- Assembly kit (including nails for bitumen shingles)
- Bitumen shingles are supplied as optional extras
- Roof and floor boards from 19 mm thickness, T&G
- Terrace boards included
- This model is reversible (during installation)
- Double roof supplied as optional extra

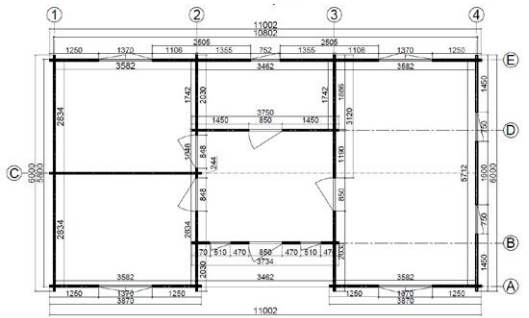
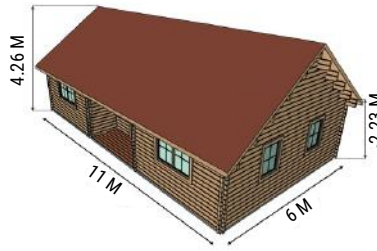

Living area – 55 m²

* Rounded notches maybe available on request.



mm

44



m

11x6



m

10.8x5.8



m²

61.06



m

2.23



m

4.26



m

0.2



m²

82.87



vnt.

5



vnt.

9



mm

19



+



Kristi / Borneo

Size 11x6 m

£37500

In 44mm



44 mm straight



44-50-44 mm straight



70 mm straight



70 mm angle*



90 mm straight



- Standard log thickness of Kristi: 44 mm, Borneo: 44-50-44 m. Log thickness 70/90 mm maybe available on request.
- Double glazed doors and windows
- Double rubber gasket for windows and doors
- Assembly kit (including nails for bitumen shingles)
- Bitumen shingles are supplied as optional extras
- Roof and floor boards from 19 mm thickness, T&G

Living area – 55 m²
 * Rounded notches maybe available on request.

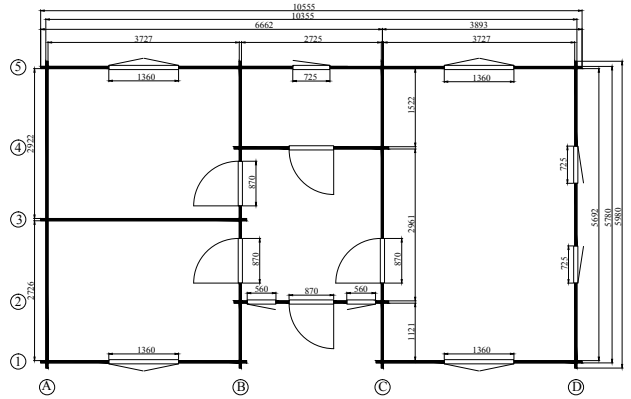

mm	m	m	m ²	m	m	m	m ²	vnt.	vnt.	mm	
44	11x6	10.36x5.78	54.48	2.09	2.77	0.2	68.9	5	9	19	-
44-50-44	11x6	10.36x5.78	52	2.09	2.77	0.2	68.9	5	9	19	-



Alicante

Size 8x14.5 m

Price on request



44 mm straight



44 mm angle*



70 mm straight



70 mm angle*



- Standard log thickness 44 mm. Log thickness 70 mm maybe available on request.
- Double glazes door and windows
- Double rubber gasket for windows and doors
- Ridge height - 3.65 m
- Assembly kit (including nails for bitumen shingles)
- Bitumen shingles are supplied as optional extras
- Roof and floor boards from 19 mm thickness, T&G

Living area – 78.57 m²

* Rounded notches maybe available on request.

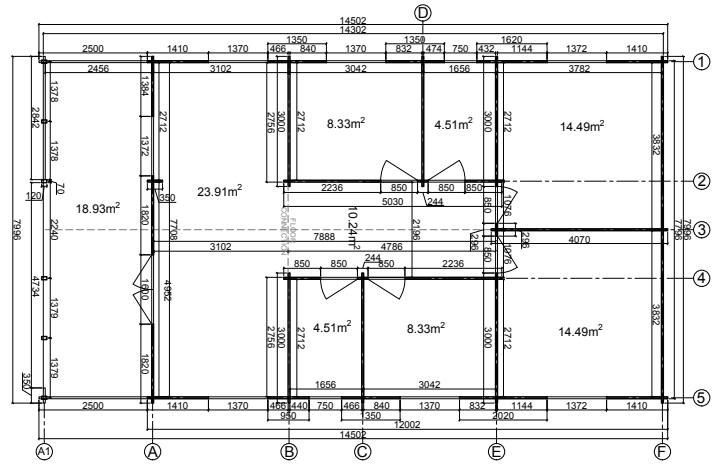

mm

44



m

8x14.5



m

7.78x14.3



m²

78.57



m

2.227



m

3.656



m

0.1



m²

130



vnt.

6



vnt.

9



mm

19



-

-



Garage, WG

Size 4x6 m

£7980



44 mm straight



44 mm angle*



- Log thickness 44 mm
- Double glazed doors and windows
- Double rubber gasket for windows and doors
- Assembly kit (including nails for bitumen shingles)
- Heavy duty wooden garage door, floor boards and bitumen shingles are supplied as optional extras
- Roof and floor boards from 19 mm thickness, T&G
- Garage has no floor
- This model is reversible (during installation)

* Rounded notches maybe available on request.

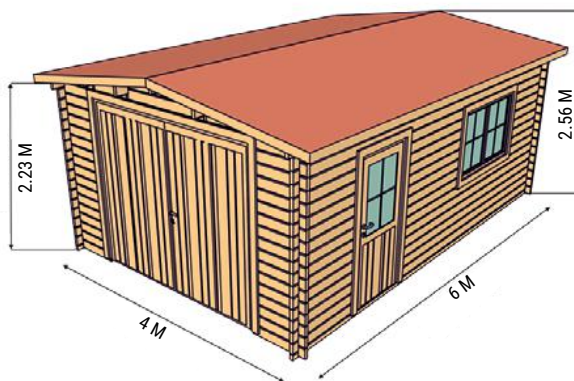

44	4x6	3.8x5.8	21.2	2.23	2.56	0.3	25.87	2	1	-	+

Garage Modern, WG

Size 4x6 m

£7980



44 mm straight



44 mm angle*



- Log thickness 44 mm
- Double glazed doors and windows
- Double rubber gasket for windows and doors
- Assembly kit (including nails for bitumen shingles)
- Heavy duty wooden garage door, floor boards and bitumen shingles are supplied as optional extras
- Roof and floor boards from 19 mm thickness, T&G
- Garage has no floor
- This model is reversible (during installation)

* Rounded notches maybe available on request.

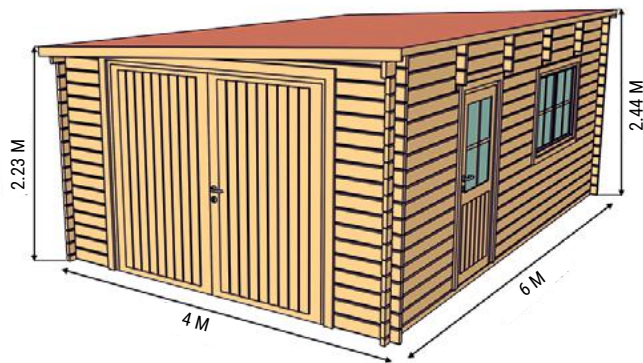

44	4x6	3.8x5.8	21.2	2.23	2.44	0.3	24.18	2	1	-	+

Double wooden carport with shed

Size 8x6 m



44 mm straight



44 mm angle*

- Log thickness 44 mm
- Double glazes door and windows
- Double rubber gasket for windows and doors
- Assembly kit (including nails for bitumen shingles)
- Bitumen shingles are supplied as optional extras
- Roof and floor boards from 19 mm thickness, T&G
- Garage has no floor
- Heavy duty wooden garage door, floors boards and bitumen shingles are supplied as optional extras
- This model is reversible (during installation)

* Rounded notches maybe available on request.

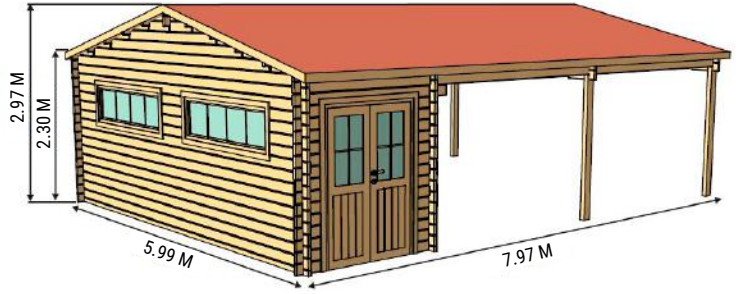

44	8x6	1.923x5.813	10.52 33.37	2.295	2.97	0.1	52	1	2	-	+

Garage with carport

Size 6x6 m

£10999



44 mm straight



44 mm angle*

- Log thickness 44 mm
- Double glazed doors
- Double rubber gasket for windows and doors
- Assembly kit (including nails for bitumen shingles)
- Heavy duty wooden garage door, floor boards and bitumen shingles are supplied as optional extras
- Roof and floor boards from 19 mm thickness, T&G
- Garage has no floor
- This model is reversible (during installation)

* Rounded notches maybe available on request.

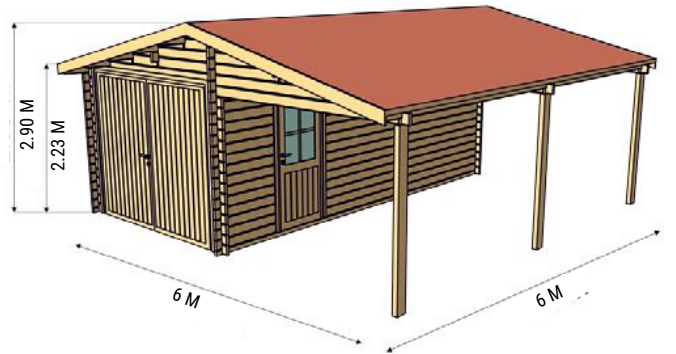

44	6x6	2.84x5.73 2.84x5.73	16.276	2.23	2.90	0.3	49.7	2	1	-	+

Double garage, WG

Size 6x6 m

£11250



44 mm straight



44 mm angle*

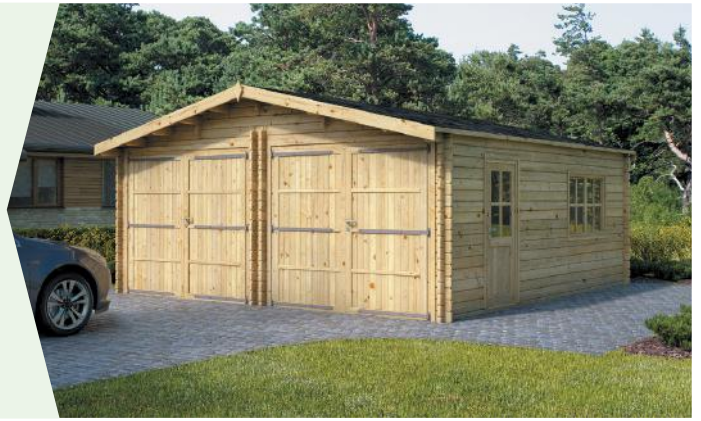

- Log thickness 44 mm
- Double glazed doors and windows
- Double rubber gasket for windows and doors
- Assembly kit (including nails for bitumen shingles)
- Heavy duty wooden garage door, floor boards and bitumen shingles are supplied as optional extras
- Roof and floor boards from 19 mm thickness, T&G
- Garage has no floor
- This model is reversible (during installation)

* Rounded notches maybe available on request.

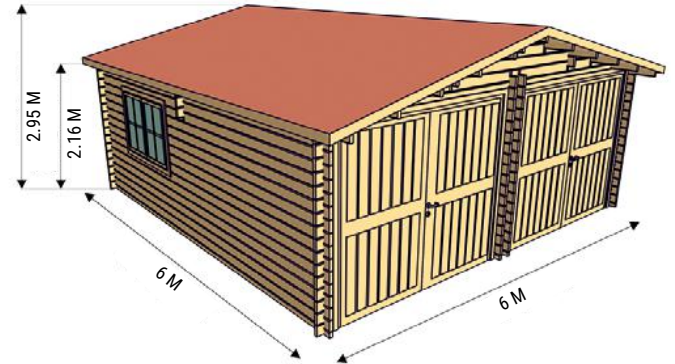

44	6x6	5.8x5.8	32.63	2.16	2.95	0.3	41.47	3	2	-	+

Garage with storage, WG

Size 6x6 m

£10999



44 mm straight



44 mm angle*



- Log thickness 44 mm
- Double glazed doors and windows
- Double rubber gasket for windows and doors
- Assembly kit (including nails for bitumen shingles)
- Heavy duty wooden garage door, floor boards and bitumen shingles are supplied as optional extras
- Roof and floor boards from 19 mm thickness, T&G
- Garage has no floor

* Rounded notches maybe available on request.

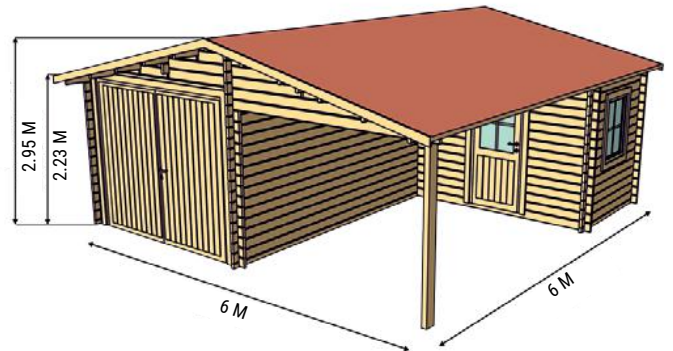

44	6x6	5.8x5.8	24.46	2.23	2.95	0.2	40.38	2	1	-	-

Symbols



Wall thickness



External dimension



Base size



Floor area



Wall height



Ridge height



Roof overhang



Roof area



Door



Windows



Floor boards



Reversible



44 mm straight



44 mm angle



70 mm straight



70 mm angle

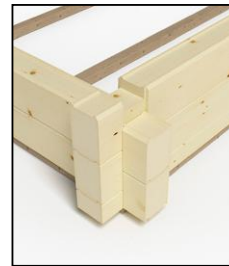

90 mm straight



44x50x44 mm straight

Bitumen shingles

Bourne Green

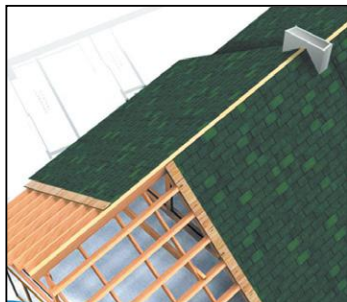

UK431-1001

Ridge/Edge Green tiles – 0001

Bourne Red



UK432-1029

Ridge/Edge Red tiles – 0025

Bourne Grey



UK433-1060

Ridge/Edge Grey tiles – 0022

Bourne Black



UK435-1025

Ridge/Edge Black tiles – 0007

Hexham Green

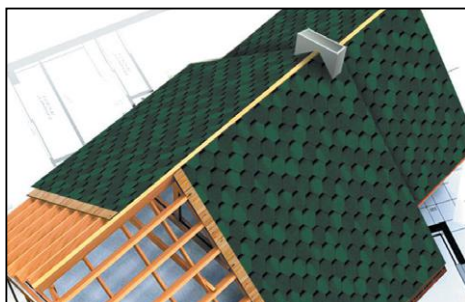

UK421-1611

Ridge/Edge Green tiles – 0001

Hexham Red



UK422-0822

Ridge/Edge Red tiles – 0025

Hexham Grey



UK423-1610

Ridge/Edge Grey tiles – 0022

One pack contains 3 m²

One pack ridge/edge tiles contains – 5 m², cover 20 linear m of roof edge or 12 m of ridge